

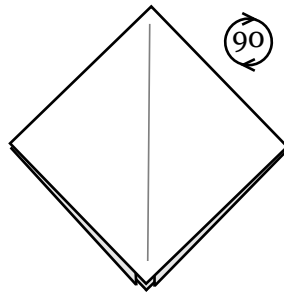

Lily Pad

© B. Domangue 2014
Leaf Piece Origami

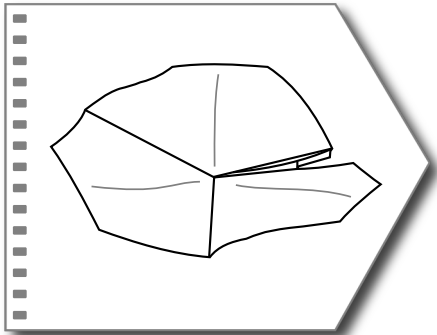

1. Begin with a square base. Then, rotate 90 degrees clockwise.

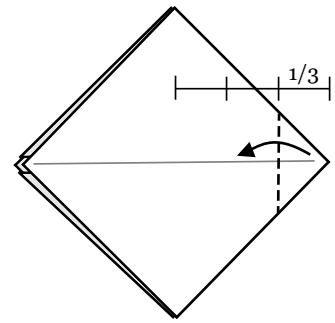

2. Measure $1/3$ from point to center of model. Valley fold.

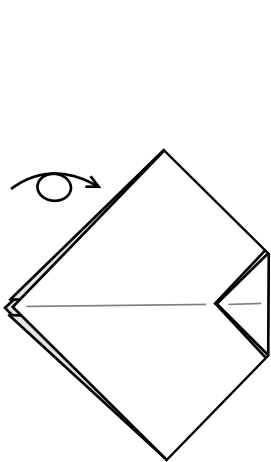

3. Flip over.

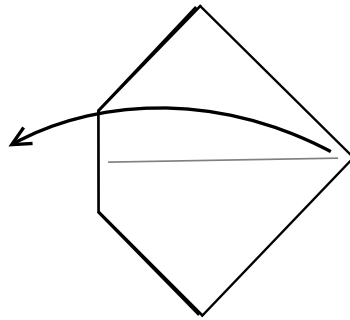

4. Pull out flap to partially unfold model.

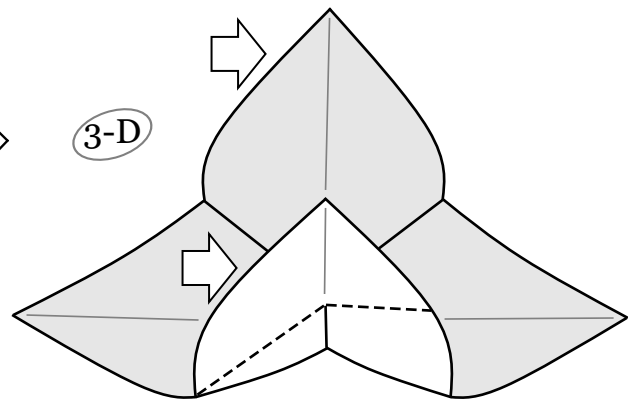

5. Flatten to one side.

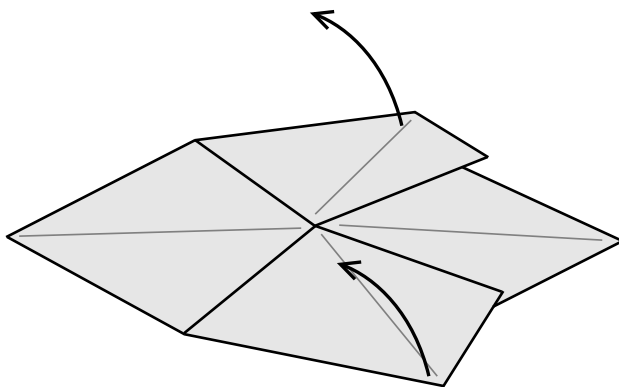

6. Unfold to step 5.

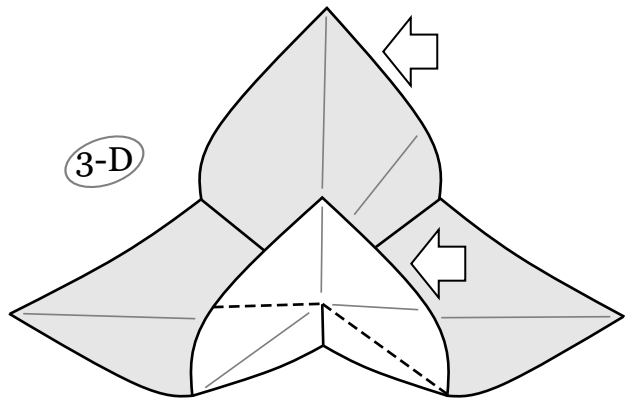

7. Flatten to other side.

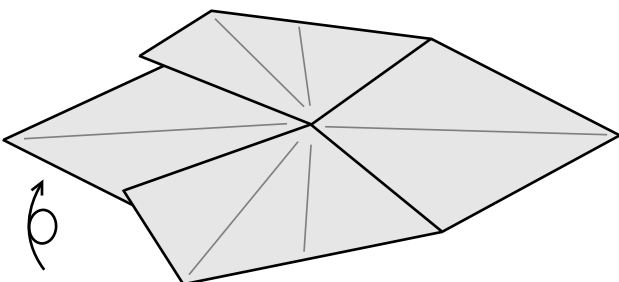

8. Flip over.

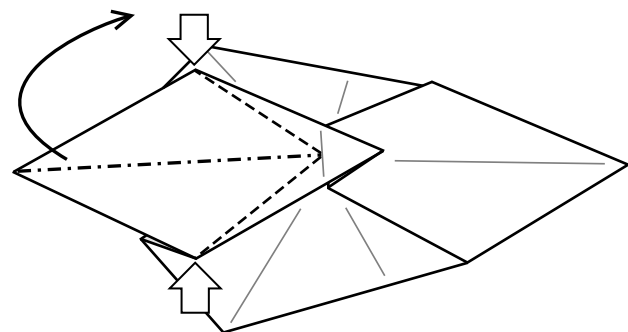

9. Crease where indicated. Then, press from sides to lift flap up.

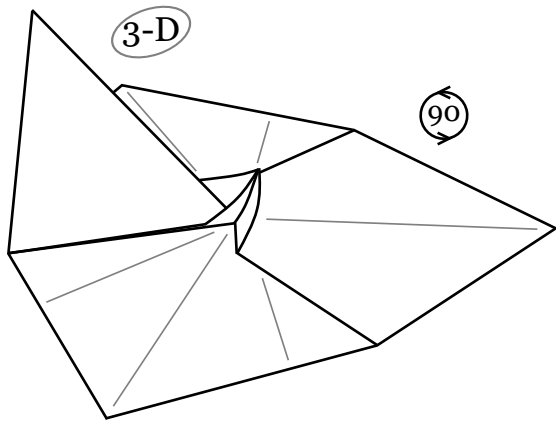

10. Rotate model 90 degrees counter-clockwise.

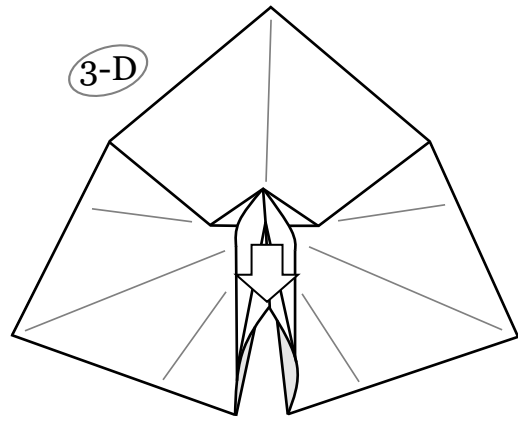

11. Squash center flap downward.

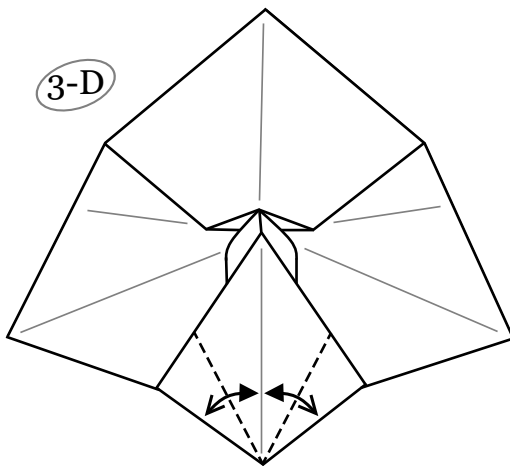

12. Valley fold edges to center, then unfold.

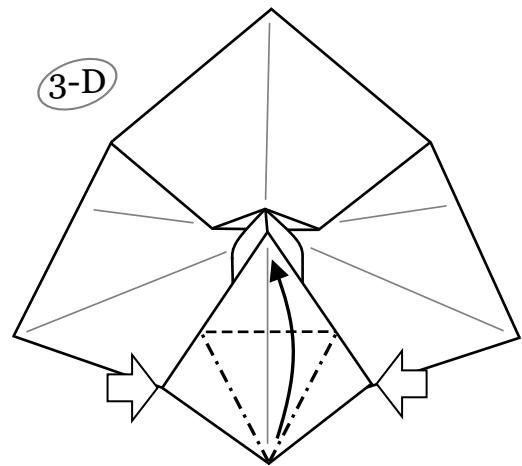

13. Petal fold.

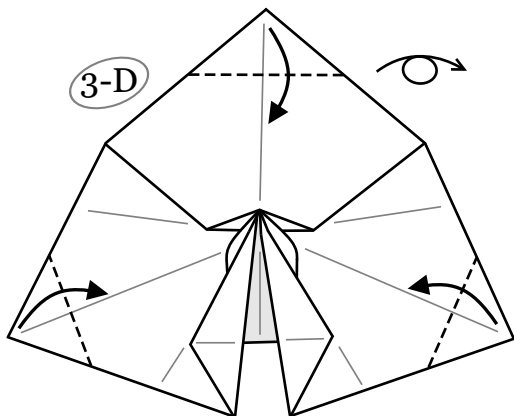

14. Valley fold corners and flip the model over.



15. Completed lily pad.